

Article number: 20908STM2215AA

Description: E+G Threaded plug DIN 908-ST-M22x15-AA

Measures

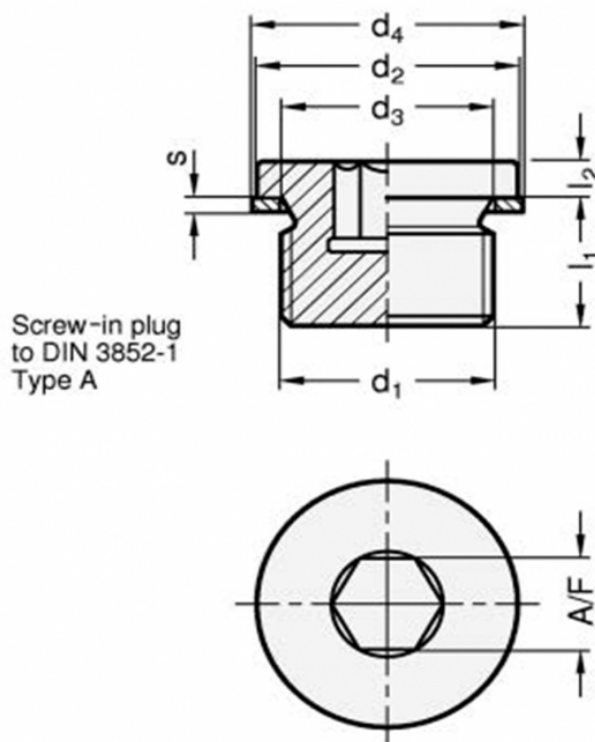

A/F	= 10
d1	= M22x15
d2h14	= 27
d3	= 22.3
d4	= 27
l1	= 14
l2	= 4
s	= 1.5

Weight in (g) = 50